

Data Sheet



Article number: 07148403001

Description: Universal joint single 0.148.403.001
S=392 X= Bore 60 H7 with keyway

Measures

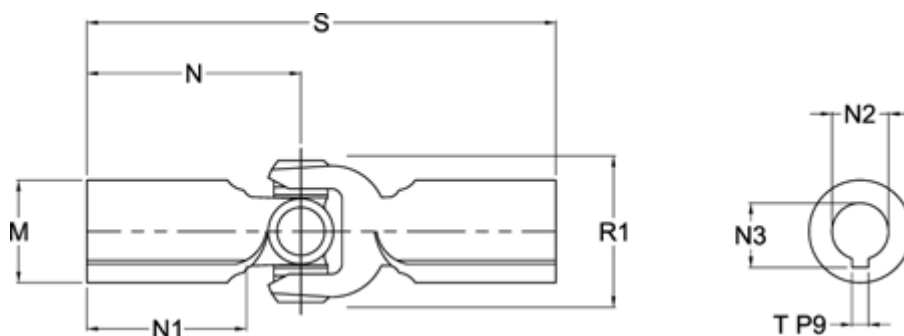

M	= 100	T = 18 P9
Max. Bending Angle degrees	= 35	
N	= 196	
N1	= 90	
N2	= 60 H7	
N3	= 64,4 +0,2	
R1	= 138	
S min	= 392	